

DMS TILT

DMS-08 PTS100

DMS
DMS Technologie GmbH

TECHNICAL DATA

Weight (incl. bolts)	[kg]	> 250
Swivel angle	[°]	180
recomm. closing pressure	[bar]	35-50
Opening pressure	[bar]	min. 35 max. 240
Tilting pressure	[bar]	210
Torque at 207 bar	[Nm]	6650
Holding torque at 225 bar	[Nm]	20450
max. hook load	[kg]	5000
comp. to Symlock		SY-08

TECHNICAL DRAWING

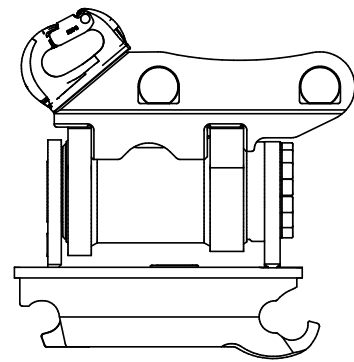

For more information and a 3D preview, visit www.dms-tec.de/en

